

FURUNO

SERVICE MANUAL

SATELLITE COMPASS

MODEL SC-50/110



FURUNO ELECTRIC CO., LTD.
NISHINOMIYA, JAPAN



(Elemental Chlorine Free)

The paper used in this manual
is elemental chlorine free.

© **FURUNO ELECTRIC CO., LTD.**

9-52 Ashihara-cho,
Nishinomiya 662-8580, JAPAN

Telephone : 0798-65-2111

Fax : 0798-65-4200

FURUNO Authorized Distributor/Dealer

All rights reserved.

Printed in Japan

FIRST EDITION : NOV. 2005

Pub. No. SME-72510-A

(KAOK) SC-50



* 0 0 0 1 5 8 9 1 3 0 0 *



* S M E 7 2 5 1 0 A 0 0 *

Contents

1. Overview	1
2. Maintenance Menu	2
1) MONITOR display	2
2) COMPASS display	3
3) R MONITOR display	3
4) R-CALIB display	4
5) RATE ERR display	5
6) OUTPUT display	5
7) ALARM display	6
8) ANALOG display	6
9) ANT MONI display	6
10) MESSAGE display	8
11) REC MONI menu	8
3. Replacement of Battery	9
4. Reading Program Number	9
5. Program Upgrade	10
1) MAIN board	10
2) CPU board	11
6. Maintenance	12
6.1 Adjustment	12
6.2 Line voltage check	12
6.3 Jumper setting.....	12
6.4 LED	12
7. Location of Parts.....	13
Appendix 1 Protection of ICs in Data Output Circuit	15
Appendix 2 Modification on Data Output Circuit	20
Exploded View (Parts List)	
Radome Antenna, C7251-E01	D-1
Processor Unit, C7251-E02	D-2
Schematic Diagrams	
Interconnection Diagram, C7251-C01	S-1
Processor Unit (SC-510), C7251-K01	S-2
POWER Board (20P8181, 1/2), C7251-K02	S-3
POWER Board (20P8181, 2/2), C7251-K03	S-4

1. Overview

The satellite compass, SC-50/110 calculates the heading by using the carrier signal of the GPS satellite signals. The system also calculates the heading with three rate sensors. When the satellite signal is blocked, the system outputs the heading data based on the rate sensor signal for a maximum of 5 minutes.

The system always compares GPS heading with rate sensor heading. If the difference between two exceeds the preset value, an alarm is generated.

The system needs about 15 minutes for settling time at GPS cold start: 12 minutes for cold start and 3 minutes for settling time.

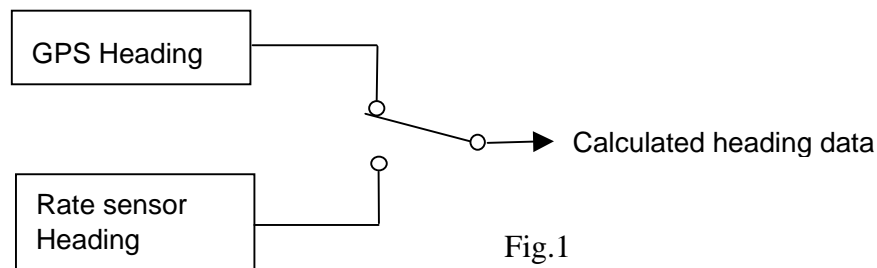

Table below compares SC-50/110 to SC-60/120.

	SC-50/110	SC-60/120
Number of output port	Heading and NAV (IEC/AD-10): 5, Interval and baud rate selectable Heading (AD-10): 1 Pitch/Roll analog: 1	Heading (IEC/AD-10): 3 NAV: 1 (1 sec/4800 bps)
Output connector	Terminal board	Waterproof connector
Processor unit	W: 300, B: 200, H: 60	W: 335, B: 265, H: 103
Factory-default setting	Wall (Bulkhead) mount	Floor mount

Output of Heading Data

Heading data is output from HDG OUT ports. Either IEC or AD-10 heading data is output from HDG OUT 1 to HDG OUT 5 ports according to menu setting. OUTPUT 6 port outputs only AD-10 format heading data. When the port is selected for IEC output, two receivers are connected to the same port: #1(Data-H) and #2 (Data-C), and #3 (Data-H) and #4(Data-C). Thus, when HDG OUT ports 1 to 5 are used for IEC ports, 10 receivers can be connected to the system. Not only heading data but also NAV data is output from IEC port.

Difference between 20P8178A and 20P8178B

The MAIN board, 20P8178A is for SC-50 and 20P8178B for SC-110. The board carries a label "A" or "B." The difference between A and B is software, but the program number is the same on top of the program ROM.

2. Maintenance Menu

The system provides TEC menu or Maintenance menu for servicing. To show TEC menu, press and hold down MENU and ENT keys simultaneously until the menu appears after three beeps. It takes about 8 seconds to hear the third beep. Release the finger from MENU key, and then ENT key. If you release the finger from ENT key first, Main menu appears. This procedure is the same as SC-60/120.

TEC MENU	
HDG SETUP	MONITOR
COMPASS	R MONITOR
R-CALIB	RATE ERR
OUTPUT	ALARMS
ANALOG	ANT MONI
MESSAGE	REC MONI

Fig. 2 TEC (Maintenance) menu

1) MONITOR display

Figure 2 shows MONITOR menu.

MONITOR			
	YAW	ROL	PIT
SC-OUT:	182.8	+0.1	+0.0
GPS:	182.8	+0.2	+0.1
ANG-V:	-1.8	+1.1	+1.7
R-OFF:	-204	0	0
CAL	0	0	
CK-FLG	0	00	

Fig.3 MONITOR menu

SC-OUT: Output of the satellite compass (degree)

GPS: Values calculated by using GPS signal (degree)

ANG-V: Angular velocities of rate sensors (degree/sec)

R-OFF: Offset values of rate sensors.

CAL (Calculation): 0 when heading is calculated normally. (Base lines 1 and 2)

CK-FLG (Check Flag): Number of detected error flag (0 normally). The system works normally even with a small number.

2) COMPASS display

MASK-EL is used to set a minimum elevation angle of the satellite. The satellite of which elevation angle is lower than MASK-EL is not used for heading calculation.

Default: 5 degrees.

DO NOT change GPS DELAY, TIME CONST, SDEV-S, SDEV-C, and CHK NEW SV.

COMPASS	
MASK-EL	: 05°
GPS DELAY	: 0.220 SEC
TIME CONST	: 01 SEC
SDEV-S	: 0.0016
SDEV-C	: 0.0069
CHK NEW SV	: 0.20

Fig.4 COMPASS display

3) R MONITOR display

“Rate sensor Monitor” display shows rate sensor errors as below.

WA SHIFT: Shows the difference between GPS and rate sensor.

DIFF RET: Shows an error if detected; 0: no error and 1: error.

WA SA: Compares succeeding two Heading (GPS + Rate sensor) outputs.

R MONITOR				
18:52:49				
	YAW	ROL	PIT	Shows difference between GPS and rate sensor.
WA SHIFT	+0.0°	+0.0°	+0.0°	
DIFF RET	0	0	0	Shows an error. 1: error, 0: no error
B HEALTH	1			
RATE SET	0000			Factory use
WA SA	0.0			Factory use
		00		

Fig.5 R MONITOR display

4) R-CALIB display

R-CALIB (Rate sensor Calibration) is used to enter the calibration value of the rate sensor at factory. It is not necessary to change this value when the rate sensor is replaced with new one. However, the value on top of the original sensor is written on top of the replacement sensor for future service.

R-CALIB	
S1	: +0.0%
S2	: +0.0%
S3	: +0.0%

Fig.6

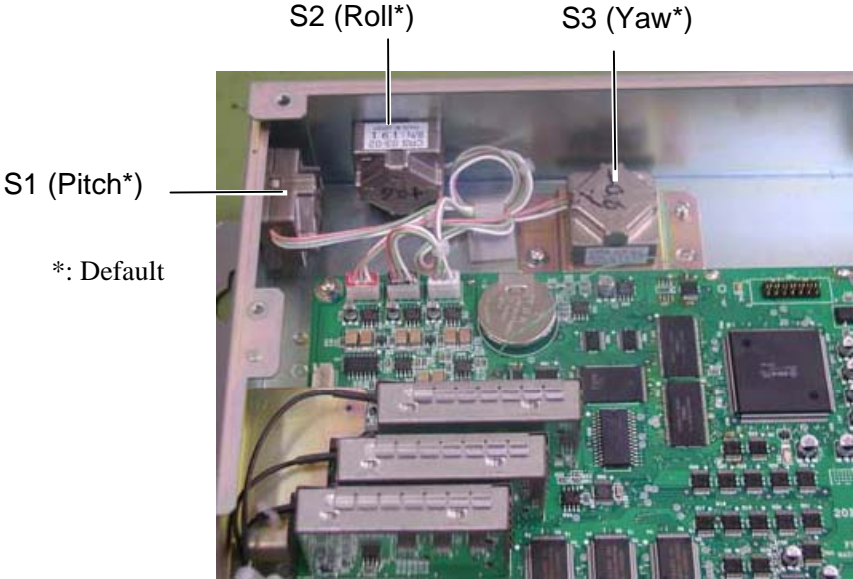

Fig. 7 Rate sensors in Processor Unit

5) RATE ERR display

This menu sets the level to trigger the heading error alarms; NO HEADING OUTPUT and RATE ERROR. The system compares the output of the angular rate sensor with one obtained by the GPS signal. In the following example, an error is detected when the difference is 2.0° or more. An alarm is generated according to SHIFT CONT setting. In the example below, an alarm is generated when Roll sensor has four consecutive errors.

YAW LIMIT: Used to detect Yaw output error. Successive two yaw data (GPS + Rate sensor) is compared. In the example below, an alarm is generated when the difference is 1.00° or more.

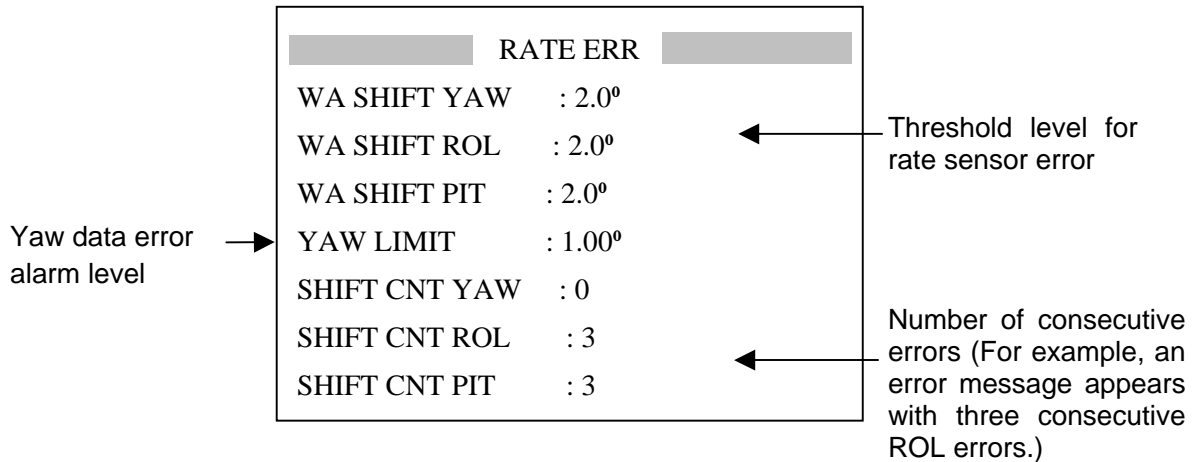

Fig. 8 Rate error display

When the rate sensor error appears after the installation, first check that the rate sensor is mounted and the installation menu is set correctly. If yes, increase the SHIFT CNT only 1. For example, if RATE ERROR! (YAW) is displayed, change SHIFT CNT YAW from 0 to 1. Never change the setting of WA SHIFT and YAW LIMIT.

6) OUTPUT display

DO NOT change the setting in this menu, except for HDM. R&D engineers use this menu for investigation. HDM is changed to TRUE if necessary.

OUTPUT	
M2 DATA	: OFF
GPS DATA	: OFF
LOG SENTENCE?	
HDM	: MAG
WAAS	: OFF
PITCH ROLL	: ABSOLUTE

Fig. 9

7) ALARM display

This menu sets the ALARM port signal. When ALARM MODE is set to “STOP,” the alarm signal is not sent out after acknowledgement. When selected “Continue,” the system continues to output the alarm signal.

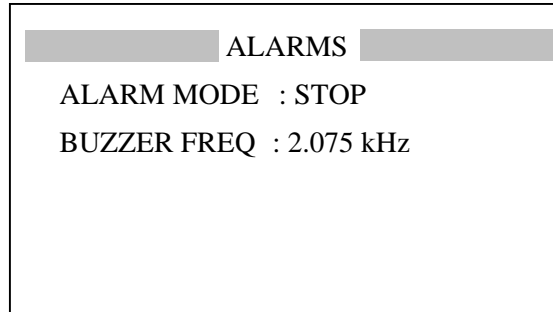

Fig. 10

8) ANALOG display

This menu is used to test and compensate the motion sensor output signal. Set the desired angle on the ANGLE line and the set angle data is output from “ROLL” and “PITCH” ports. If necessary, enter the Offset value (digital value).

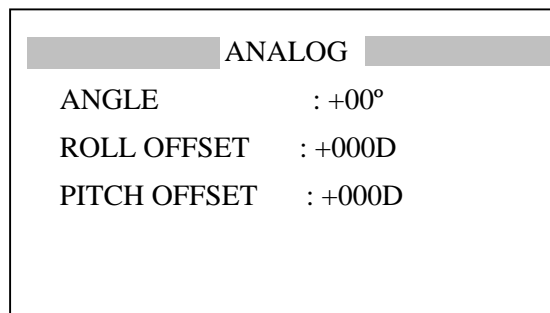

Fig. 11

9) ANT MONI display

Figure 12 shows an example of Antenna Monitor display.

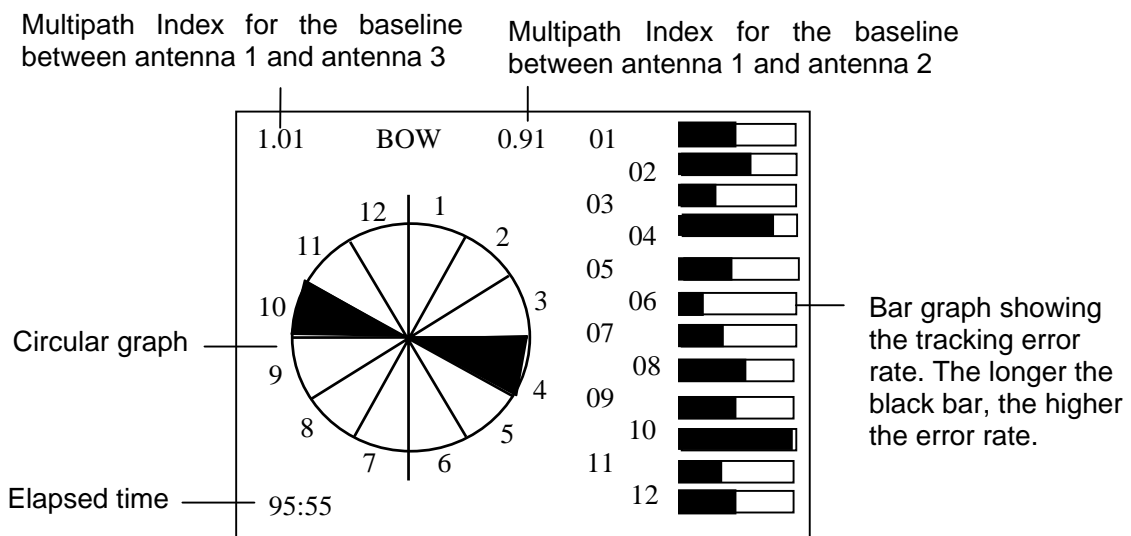

Fig.12 ANT MONI display

The display consists of four indications; a circular graph which shows direction where the tracking error rate is the highest, a bar graph which shows tracking error rates in 12 directions, multipath indexes, and elapsed time.

Circular graph: Shows the relation of 12 directions to the bow. The direction of the highest tracking error rate and its opposite direction are painted. Note that the sectors are painted even when no heading loss problem occurs.

Bar graph: Shows tracking error rate in 12 directions. The bar number corresponds to the sector number. The longer the bar, the more the error occurs. The blockage of the satellite signal by surrounding may cause the tracking error. Note that the sector opposite to the obstacle may have the longest bar.

Multipath indexes: Shows the effect of the multipath reflection. It is around 1.0 normally. If it is 1.5 or above, the antenna must be relocated, because the system is affected by the multipath reflection. The left figure is the index for the baseline 2 (antennas 1 and 3) and the right one for the baseline 1 (antennas 1 and 2).

Elapsed time: Shows how long the data is collected. The timer starts at first power up after installation and counts up to 99 hours and 59 minutes (99:59). No measurements are made after 99 hours 59 minutes. Allow the system 12 hours or more to collect the data in various satellite configurations because the satellite configuration has little change within 12 hours.

In the example of Figure 13, the tracking error occurs at the highest rate in 10 o'clock direction. The satellite signal is blocked by an obstacle located at 10 o'clock on board a ship.

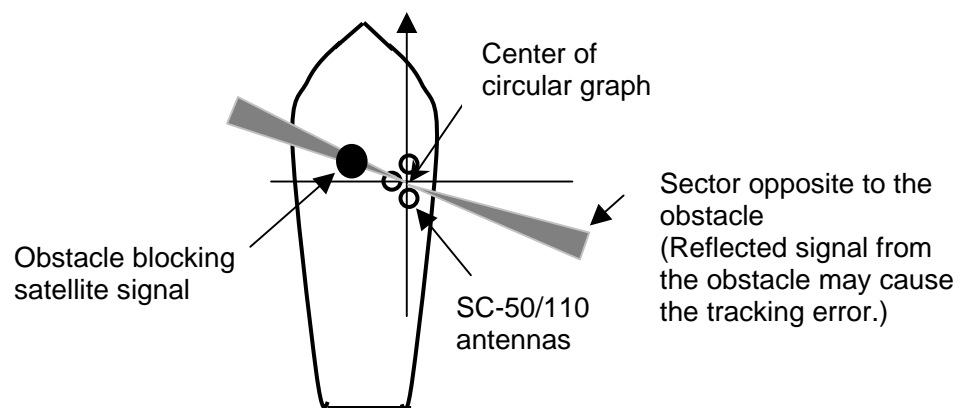

Fig.13

10) MESSAGE display

Error messages appear in the display. If RATE ERROR! appears, first check Installation Setup menu for correct setting: “Mounting” method and “Direction.”

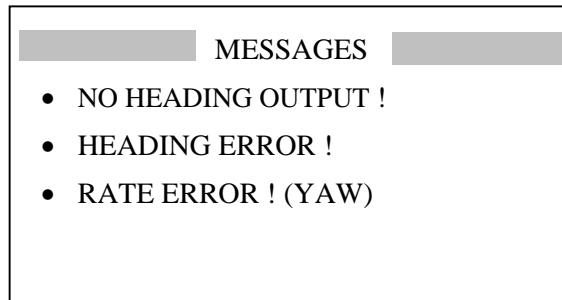

Fig.14 Error Message display

11) REC MONI menu

The REC MONI display, Figure 15 shows whether the system works normally or not. The GPS receiver having the least tracking error rate reads 1.0. The error rate of other receivers is between 0.7 and 0.9 normally. In the example of Figure 16, the receivers GPS2 and GPS3 have 20 % and 10% higher error rate than GPS1 respectively. If the error rate is 0.5 or less, the receiver and/or the antenna may be defective.

The number of the satellite being used for heading calculation is displayed at the right-hand side below CAL, and the number of the satellite being tracked below ALL. The system requires 4 or more satellites for heading calculation.

The timer is reset by selecting “CNT Reset?”.

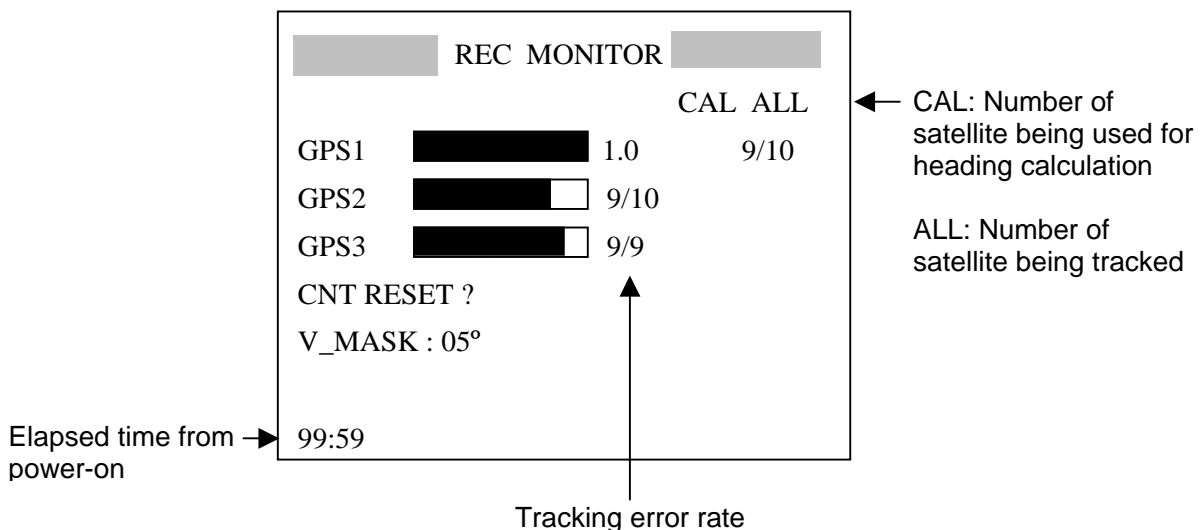

Fig.15 REC MONI display

V-MASK is used to set the angle where the satellite signal is not received for ANT MONI display. For example, if 15 degrees is entered, the satellite signal between 0° and 15° is not used to create ANT MONI display.

3. Replacement of Battery

The processor unit has a battery which backs up the RAM contents when the power is removed. When the voltage of the battery drops to 2.5 V, the message “BATTERY!” appears on the screen. To check the message, press [MENU] key and choose “MESSAGE.” The lifetime of the batteries is 3 to 5 years.

CAUTION!

Take care to avoid short-circuit of the battery. This could create a burn or fire hazard. Do not dispose of the battery in a fire or an incinerator; this may cause an explosion.

When the message BATTERY! appears, save the contents of the RAM onto the flash memory temporarily as soon as possible (within about 24 hours). If the data is transferred to the flash memory, they are not erased during the replacement.

Parts Name	Type	Code No.
Lithium Battery	CR2450-F2ST2L	000-144-941

To transfer the memory;

1. Choose EXCHANGE BATTERY? in the SYS SETUP menu.
2. Follow the instructions on the menu. Use [ENT] key to proceed the step.

To replace the battery;

3. Loosen four screws and remove the front cover.
4. Remove the MAIN board by loosening screws fixing the board to the chassis.
5. Unsolder the battery.
6. Solder new battery.

4. Reading Program Number

To display the program number list;

1. Press [MENU] key.
2. Choose SOFT VER. and press [ENT] key.
The following list appears.
3. Press [DISP] to close the menu.

SOFTWARE VERSION	
DISPLAY	205-1342-01.01
PROCESS	205-1341-01.02
GPS1	4850263003
GPS2	4850263003
GPS3	4850263003

Fig.16 SOFTWARE VERSION menu

5. Program Upgrade

The three programs are used for the SC-50/110. Two programs are used in the processor unit and one program is in the display unit. The program numbers are tabulated below. Note that the program number of SC-50 is the same as SC-110, but they are different. The program for SC-50 cannot be overwritten by the one for SC-110 in the field and vice versa.

(As of February 2005)

Unit	Board	Program No.	How to update
Processor unit	MAIN board	205-1341-01.02	By using a PC
	GPS receiver	4850263003	By replacing GPS core
Display unit	CPU board	205-1342-01.01	By using a PC

The following describes how to update the programs stored on the MAIN and CPU boards.

1) MAIN board (Processor unit)

To upgrade the program on the MAIN board;

1. Connect the serial port of the PC to J15 (D-sub) on MAIN board

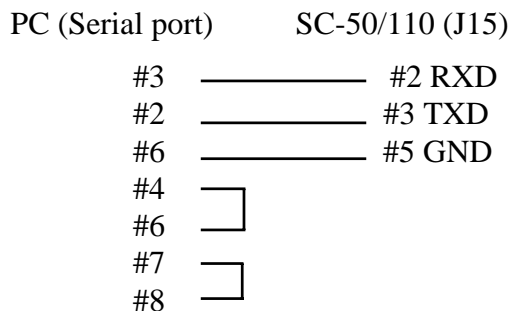

2. Turn on the PC. Do not as yet turn on the SC-50/110.
3. Click the SCUP.bat file in the SC-50/110 program file.
4. Turn on the SC-50/110 after the message “TARGET POWER ON” on the PC screen.
5. “NOW LOADING” appears on the SC-50/110 display unit, while “Now Erasing”, and “xxx percent completed” appear during program upgrade on the PC screen.
6. The program upgrade is completed with the message “Finish Version up.ted” on the PC screen. (About 3 minutes 30 seconds) The SC-50/110 displays the Heading display.
7. Turn off the SC-50/110 and turn it on again.
8. Confirm the program number through the SOFT VER. menu.

2) CPU board (Display unit)

To upgrade the program on the CPU board;

1. Connect the serial port of the PC to J15 on MAIN board in the processor unit.
2. Turn on the PC. Do not as yet turn on the SC-50/110.
3. Click the SCUP.bat file in the SC-50/110 program file.
4. Turn on the SC-50/110 after the message “TARGET POWER ON” on the PC screen.
5. “NOW LOADING” appears on the SC-50/110 display unit, while “Now Erasing,” and “xxx percent completed” appear during program upgrade on the PC screen,.
6. The program upgrade is completed with the message “Finish Version up.ted” on the PC screen. (About 3 minutes 30 seconds) The SC-50/110 displays the Heading display.
7. Turn off the SC-50/110 and turn it on again.
8. Confirm the program number through the SOFT VER. menu.

6. Maintenance

6.1 Adjustment

1) PWR board

Switching regulator frequency is adjusted on PWR board, 20P8181 as below.

Test Point	GND	Rating	Adjuster
TP2	TP1	120.0 kHz \pm 10 kHz	VR79
TP5	TP3	120.0 kHz \pm 10 kHz	VR80

2) MAIN board

Vcc-c supply voltage to Rate sensor is adjusted by VR96 on MAIN board, 20P8178.

Test Point	GND	Rating	Adjuster
#1 of J20	#2 of J20	5.0 V (Vcc-c)	VR96

6.2 Line voltage check

Line voltages are checked at J3 on the MAIN board.

Line voltage	Test Points on MAIN board	Rating
3.3 V	#4 (+) and #5(-) of J3	3.15 to 3.45 V
5.1 V (5 V)	#1 (+) and #5(-) of J3	4.94 to 5.46 V
6.5 V	#8 (+) and #5(-) of J3	6.2 to 6.8 V
13.5 V (15 V)	#7 (+) and #5(-) of J3	12.5 to 14.4 V

6.3 Jumper setting

Jumper JP1 on the MAIN board is used at factory to set the MAIN board to A or B version.

6.4 LED

CR3 on the MAIN board blinks when the CPU is running.

7. Location of Parts

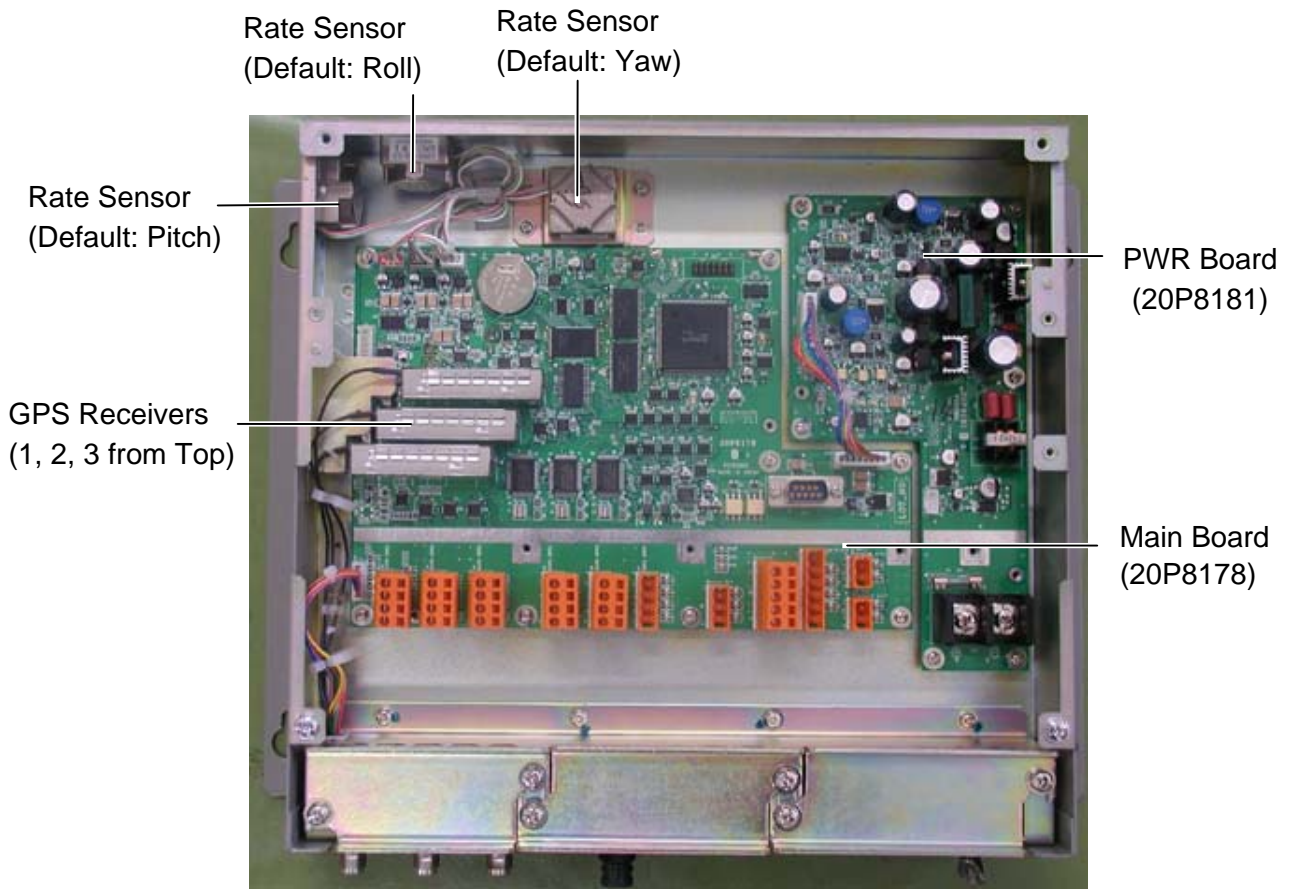

Fig. 17 Processor Unit with cover removed

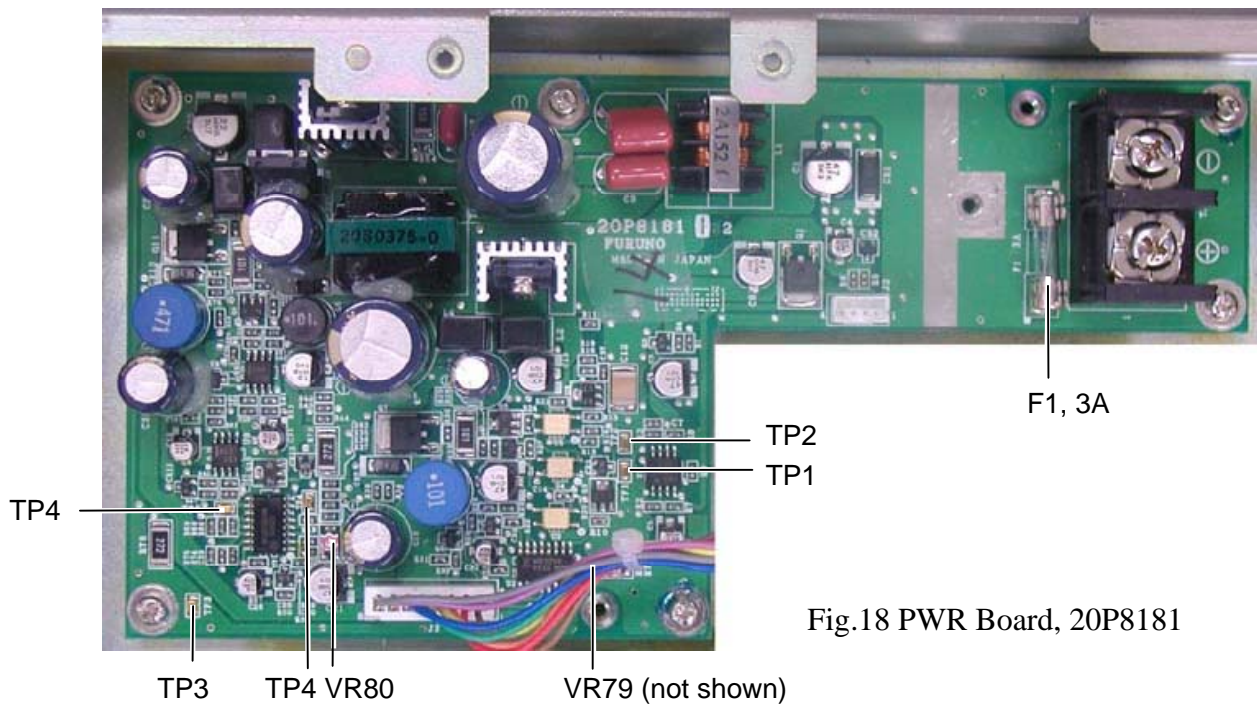

Fig.18 PWR Board, 20P8181

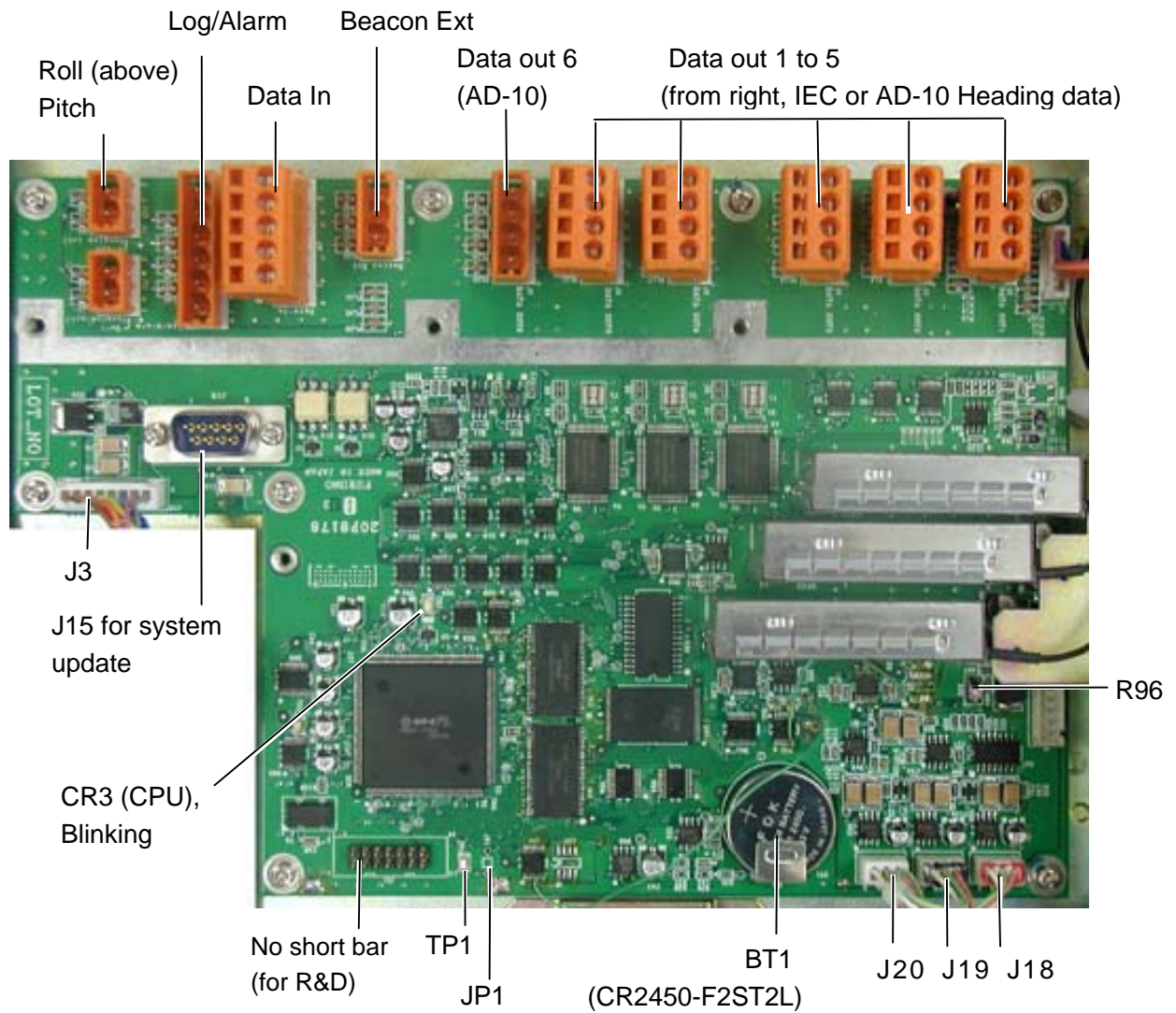

Fig.19 MAIN Board, 20P8178

Appendix 1 Protection of ICs in Data Output Circuit

Appendix 1 describes how to prevent ICs in the data output circuit temporarily. Refer to Appendix 2 for permanent remedy.

Symptom

U1, U2, and U3 in the heading output circuit are damaged.

Cause

Ground potential difference - The cable shield, or a signal return path between the circuit grounds of the equipment is not connected securely. The shield is connected to the unit through the cable clamp on SC-50/110, while the connector pin is used on SC-60/120.

Remedy

At installation: Carry out 1) to 4).

When the symptom occurs: Carry out 1) to 5).

- 1) Solder a grounding cable to the cable shield and ground it through the screw fixing the MAIN board. See the attached sheet.
- 2) Ground SC-50/110 processor unit securely.
- 3) Connect the cable shield at the end of the interconnected unit as below.
IEC61162-1 and AD-10 (photo coupler): Frame Ground (FG)
IEC61162-2 (RS422/485): Signal Ground (SG)
- 4) Connect the interconnected unit securely
- 5) Add zener diodes in the heading output circuit to protect the IC from being damaged by surge. J2 to J7

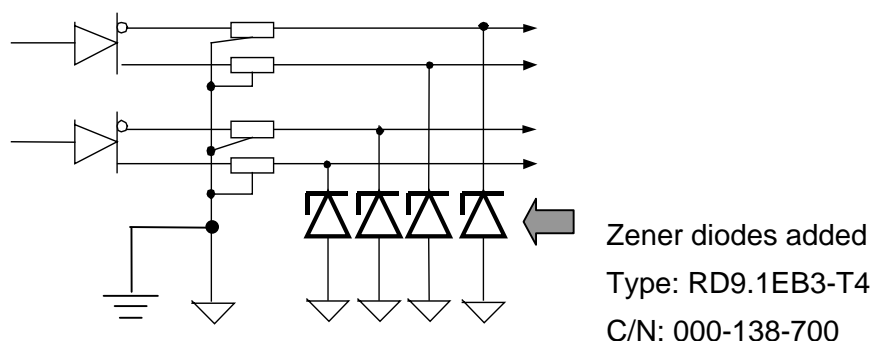

Fig.1 Zener diodes added in data output circuit

Factory-modified sets

SC-110 (SC1101): 4404-0329 and after

SC-50 (SC501): 4403-2224 and after

1. Fabrication of Signal Cable

The signal cable is fabricated as below. DO NOT hold back the cable shield over the armor. The installation manual will be revised.

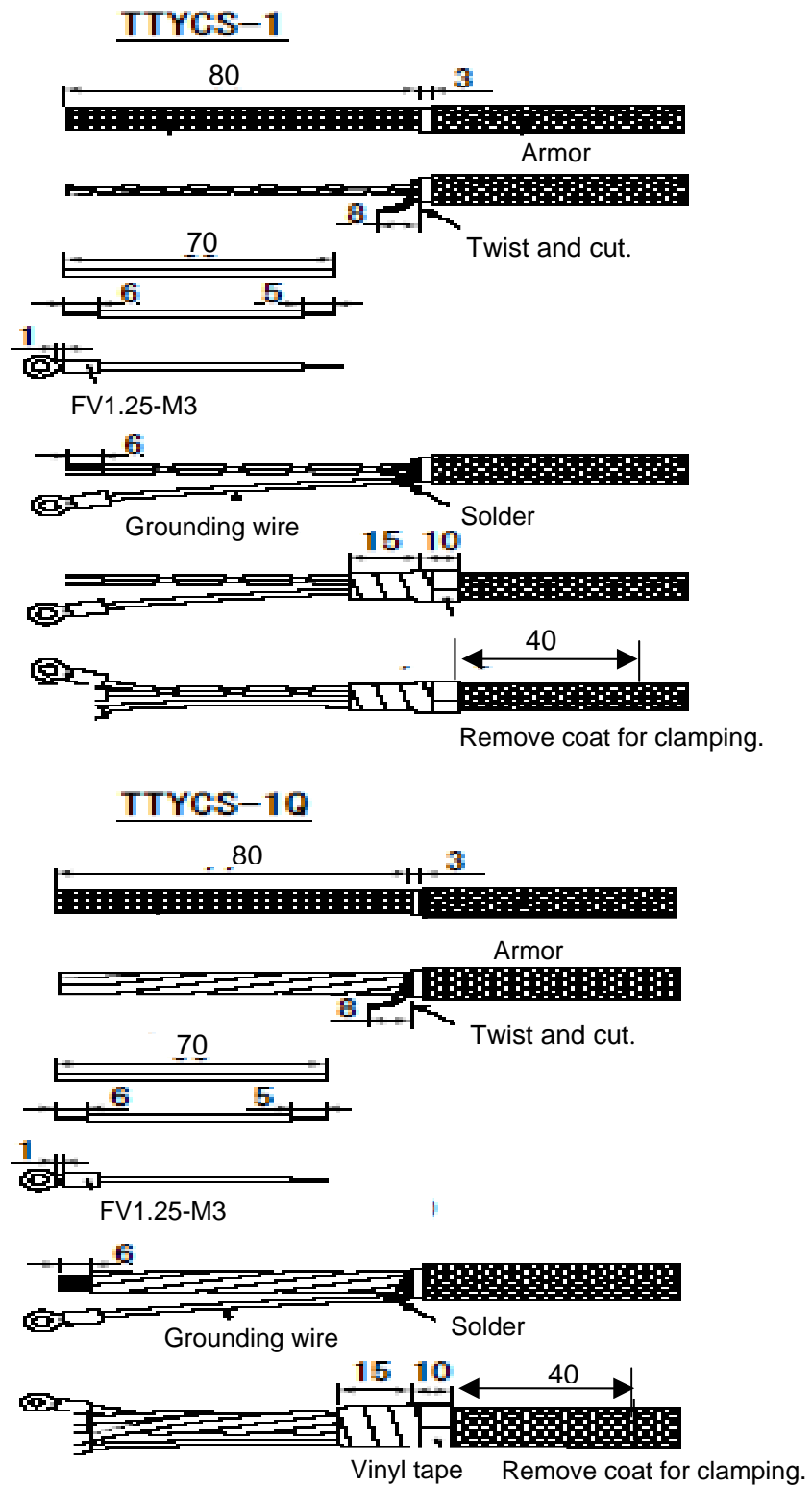

Fig. 2

2. Grounding Cable Shield

Ground the cable shield or grounding wire to the chassis by using the screw fixing the MAIN board, 20P8178 to the chassis.

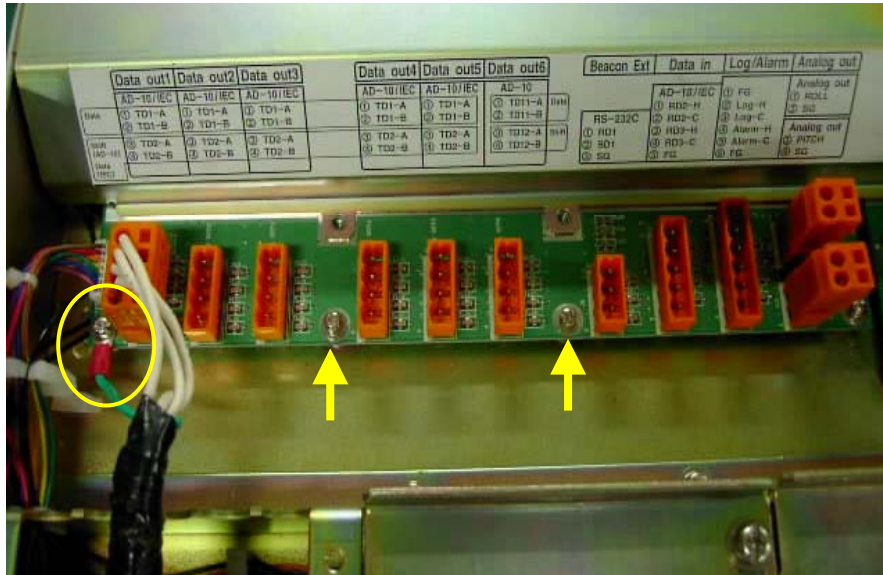

Fig. 3 Connection of grounding wire

3. Adding Zener Diodes

Zener diodes are added to the data output circuit as below.

1. Fabricate the diode as shown in the figure below.

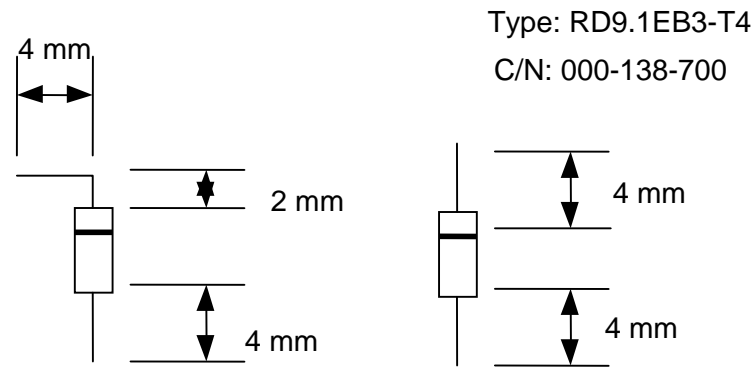
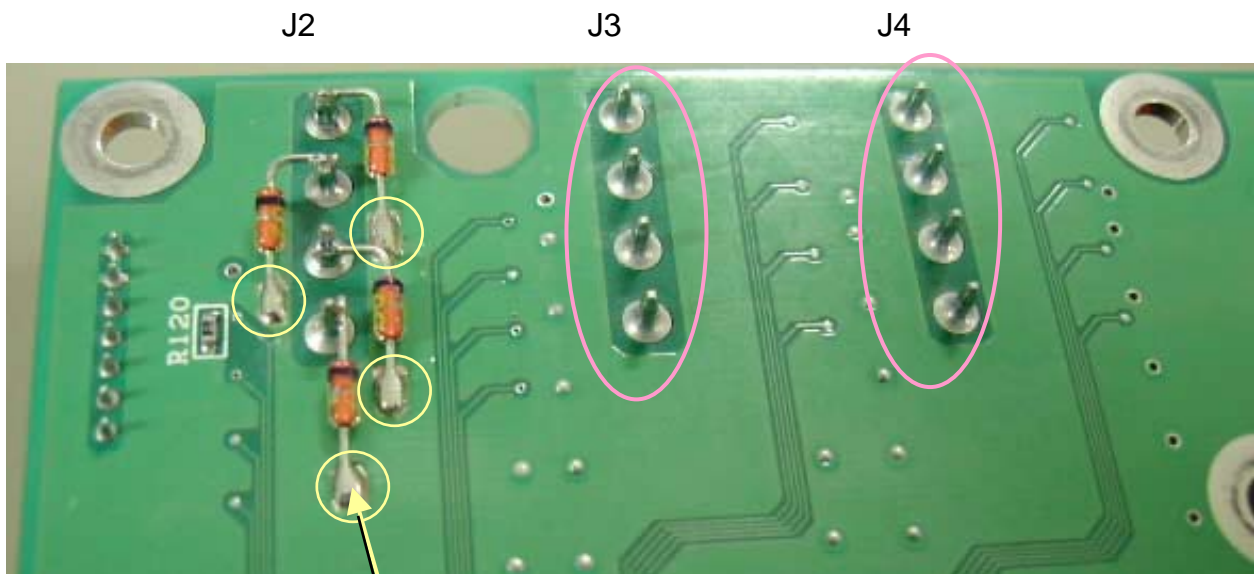

Fig. 4 Fabrication of zener diode

2. Remove the coat and solder the diode. See Fig. 5.

3. Do the same for other pins and other ports.



Remove the coat and then solder the anode.
Do the same for other diodes.

Fig. 5 Zener diodes on MAIN board, soldering side

Reference)

The following waveforms show the effectiveness of the modification. With the SC-50/110 processor unit being not modified, a spike noise is observed at the output terminal on SC-50/110 when the interconnected unit is turned on. (Fig. 6) After modification, the noise is not observed. (Fig. 7)

Before modification

Condition: SC-50 switched off

Measuring points: CH1: TD1-A (pin #1) on DATA 5 port

CH2: TD1-B (pin #2) on DATA 5 port

Ground lead: SG (=FG) on SC-50

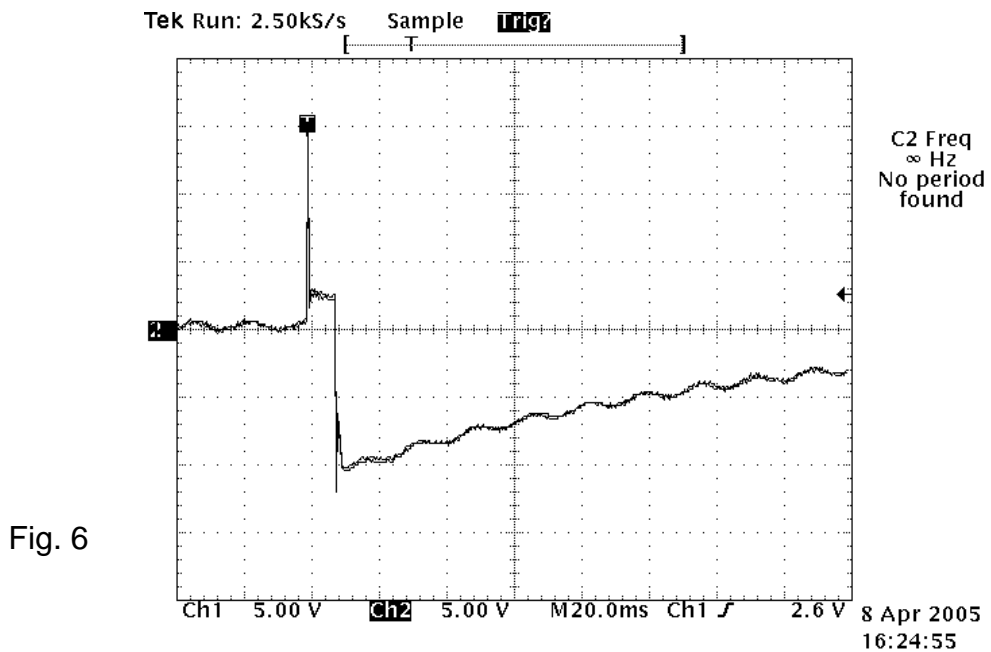

After modification

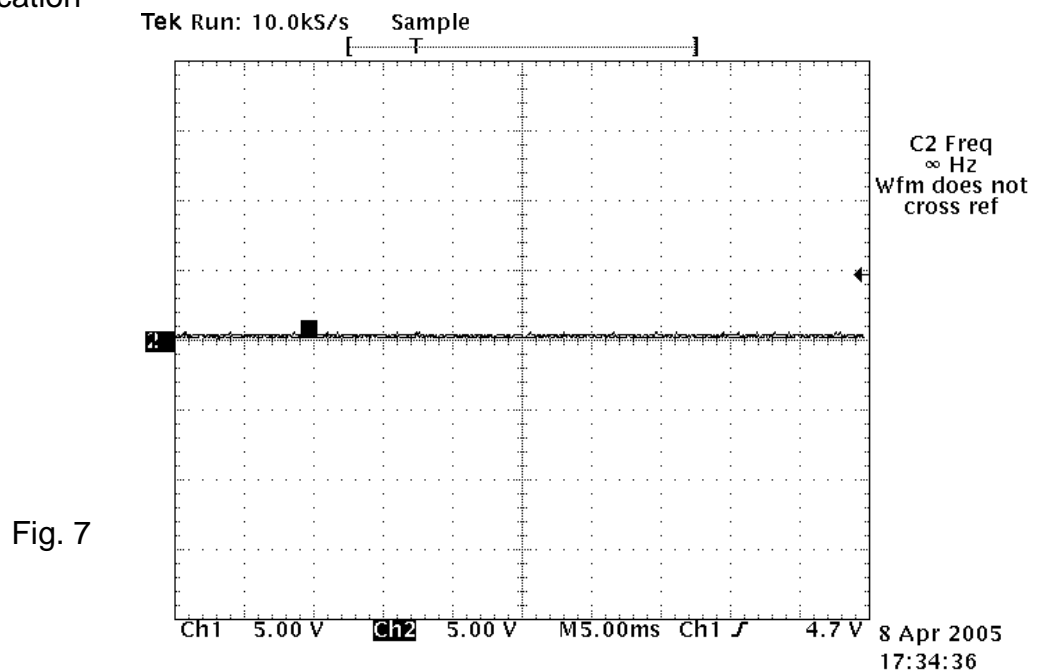

Appendix 2 Modification on Data Output Circuit

Appendix 1 describes the tentative remedy to prevent U1, U2, and U3 in the heading output circuit from being damaged.

Following modification (Table below) is the permanent remedy. The connector is changed from 4 pins to 5 pins for the connection of cable shield.

When installing the unit having the current MAIN board (-55);

- 1) Connect the cable shield to pin #5 of DATA OUT port.
- 2) Ground the frame of SC-50/110 securely.
- 3) Connect the other end of the cable shield to FG when data is IEC61162-1/AD-10 (photo coupler), or SG when data is IEC61162-2 (RS422/485).
- 4) Ground the frame of the unit connected to SC-50/110 securely.

	Before modification	After modification
U1, U2, and U3	MAX3043EUE-T	SN75ALS172DE
CR7 to CR30	RD9.1EB3-T4	1SS226-TE85LF
Connectors (J2 to J7), DATA1 to DATA 6	231-334/001-000, 4-pin connector	231-335/001-000, 5-pin connector
Plugs (P2 to P7), DATA1 to DATA 6	231-304/026-FUR, 4-pin plug	231-305/026-FUR, 5-pin plug
MAIN board	20P8178-33	20P8178-55

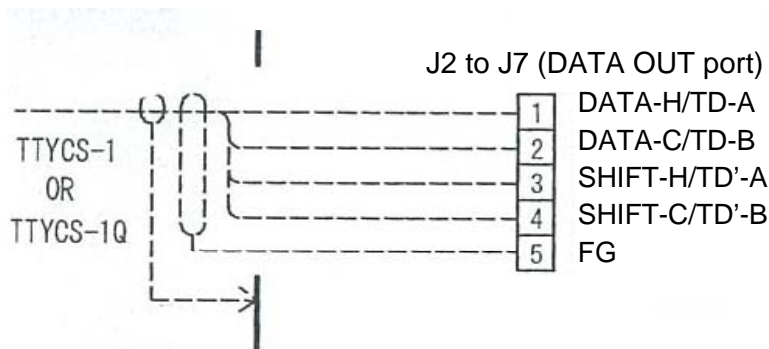

Fig.1 Connection on DATA OUT port

Factory-modified sets

SC-50 (SC501): 4403-2637 and after

SC-110 (SC1101): 4404-0360 and after

77

LID
20-024-2001-3
(100-310-663)

ワシナ G LABEL 1
86-003-1011-1
(100-236-231)

++-+ 洗機 B
WASHER HEAD SCREW
M 4X8 C2700 M B N12
(000-806-407)

スイッチ 洗機
SWITCH GASKET
20-024-2022-0
(100-310-750)

スイッチ 洗機
SWITCH MOUNTING PLATE
20-024-2005-1
(100-310-701)

警告ラベル
WARNING LA BEL
03-160-1042-0
(100-302-750)

SW-PH 洗機
POWER SWITCH ASSEM BLY
20-065(419) -4P)
(004-380-670)

++-+ 洗機 B
WASHER HEAD SCREW *B*
M 3X8 C2700W M B N12
(000-881-489)

++-+ 洗機 B
WASHER HEAD SCREW *B*
M 3X8 C2700W M B N12
(000-881-404)

洗機 洗機
PROTECTION COVER
20-024-2003-2
(100-310-682)

ケーブル 洗機 (1)
CABLE SUPPORTING PLATE (1)
20-024-2011-3
(100-310-723)

ケーブル 洗機 (2)
CABLE SUPPORTING PLATE (2)
20-024-2012-2
(100-310-732)

エッジ サドル
EDGE SADDLE
EDS-3
(000-108-152-10)

ケーブル 洗機 (1)
CABLE PLATE
20-024-2004-2
(100-310-692)

Combination of MAIN board & LABEL

MAIN BORD	LABEL
20P8178-33 の時	20-024-2023-2 (100-310-762)
20P8178-55LF の時	20-024-2023-3 (100-310-763) ●

ワシナ G LABEL
BLIND FILM
20-024-2021-2
(100-310-742)

コネクタ (23) CONNECTOR

MAIN BORD	20P8178-33の時	231-304/026-FUR (000-147-429)
MAIN BORD	20P8178-55LFの時	231-305/026-FUR (000-147-431)

MAIN ジョイント PRINTED CIRCUITBOARD

20P8178-33 から変更時は必要	SC-501	20P8178-55LF	20P8178A (LF) (004-655-690)
●	SC-1101	20P8178-55LF	20P8178B (LF) (004-655-720)

++-+ 洗機 B
WASHER HEAD SCREW *B*
M 3X8 C2700W M B N12
(000-881-404)

コネクタ (23)
CONNECTOR (23)
231-303/026-FUR
(000-148-884)

++-+ 洗機 B
WASHER HEAD SCREW *B*
M 3X8 C2700W M B N12
(000-881-404)

コネクタ (洗機)
CONNECTOR
XH8P-W-L100
(000-148-550)

PIR ジョイント
PRINTED CIRCUIT BOARD
20P8181(LF)
(004-655-740)

コネクタ (23)
CONNECTOR
231-306/026-FUR
(000-147-430)

洗機 - (洗機)
ANGULAR VELOCIT Y SENSOR
CRSO 3-02
(004-380-930)

センサー 洗機
SENSOR MOUNTING PLATE
20-024-2006-1
(100-310-711)

++-+ 洗機 B
WASHER HEAD SCREW *B*
M 3X8 C2700W M B N12
(000-881-404)

ミニクランプ
MINI CLAMP
UAMS-0 3-0
(000-136-792)

++-+ 洗機 BK
WASHER HEAD SCREW *BK*
M 2.6X5 C2700W M B N12
(000-808-932)

ハルニツク
HARNES L I FTER
HL-18-0
(000-808-214-)

ケーブル クランプ
CABLE CLAMP
CKS-0 7-L
(000-801-868-01)

ケース
CASE
20-024-2002-4
(100-310-674)

ワイヤ サドル
WIRE SADDLE
WS-1NS
(000-149-038-10)

ミニクランプ
MINI CLAMP
UAMS-05-0
(000-141-865)

++-+ 洗機 B
WASHER HEAD SCREW *B*
M 4X8 C2700W M B N12
(000-881-445)

++-+ 洗機
PAN HEAD SCREW
M 4X20 C2700W M B N12
(000-861-131)

ケーブル 洗機
CABLE ASSEM BLY
TBPJ-SFL2LP-L280
(000-148-839)

洗機 洗機
EXTERNAL TOOTH LOCK WASHER
M 4 C81W M B N12
(000-864-506)

コネクタ 洗機
CONNECTOR
PH7P-M J7P-L260
(000-148-552)

P/W 洗機
S/W 洗機
N 洗機
P/W 洗機
S/W 洗機
Wiring Nut 洗機

MODEL SC-50/110

APPROVED
06 Sep 2005
H. Kuwamura

CHECKED
06 Sep 2005
T. Yoshida

DRAWN
06 Sep 2005
S. Kubota

UNIT SC-501/1101
DWG. NO. C7251-E01-A
演算部
PROCESSOR UNIT

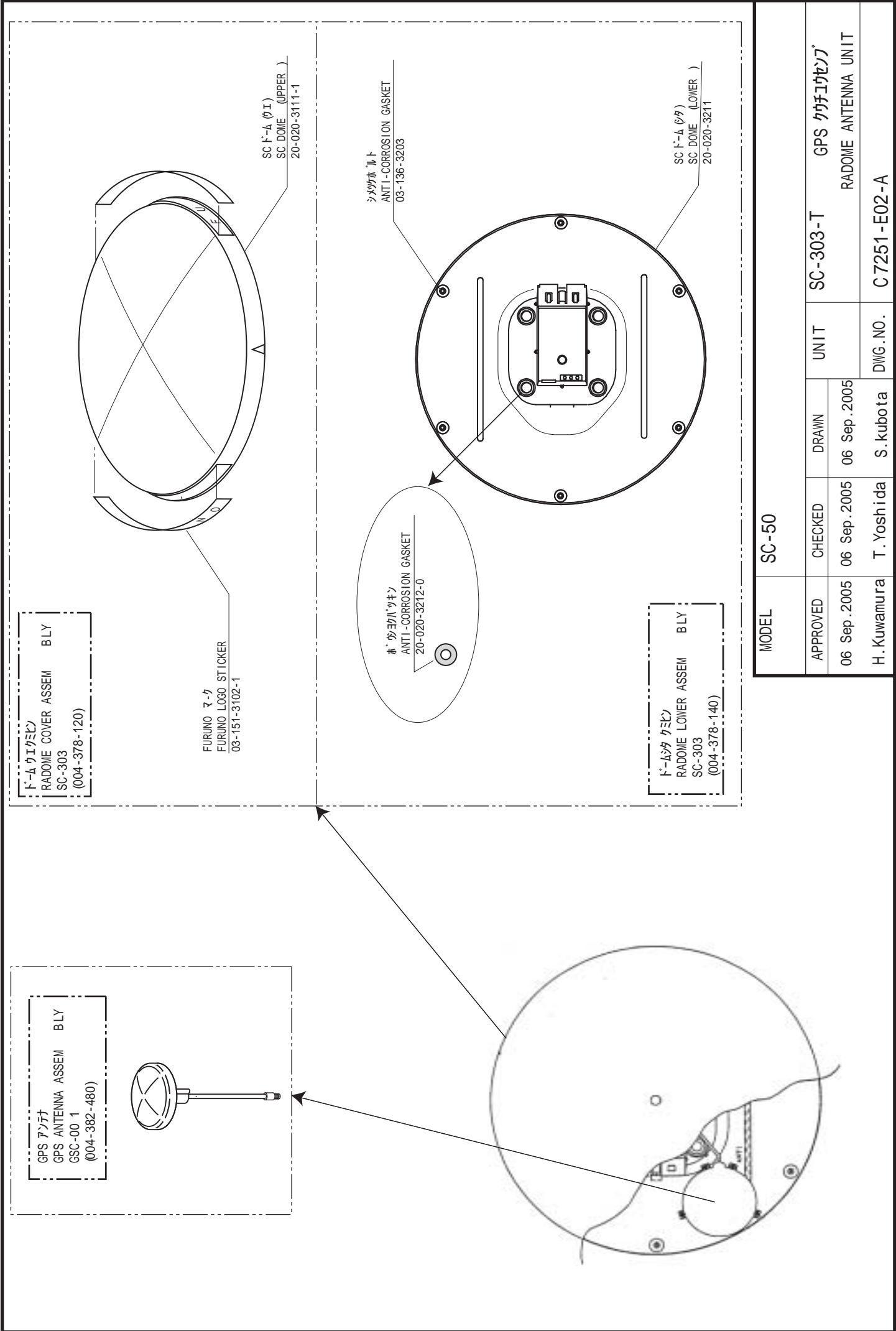

MODEL SC-50

APPROVED	CHECKED	DRAWN	UNIT	SC-303-T	GPS アンテナ
06 Sep.2005	06 Sep.2005	06 Sep.2005		RADOME ANTENNA UNIT	
H.Kuwamura	T.Yoshida	S.kubota	DWG.NO.	C7251-E02-A	

A

B

C

D

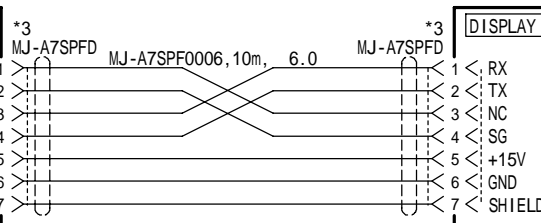
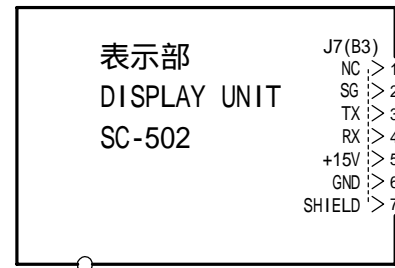

AD-10/IEC61162
RS-485 LEVEL

レーダー
オートパイロット
ソナー
潮流計

RADAR
AUTOPILOT
SONAR
CURRENT INDICATOR

方位信号出力
HDG OUT

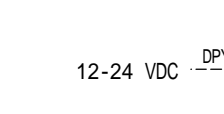
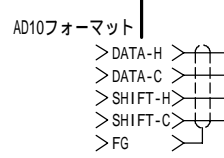
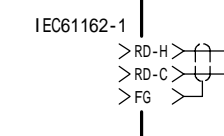

- 注記
- * 1) 造船所手配
 - * 2) オプション
 - * 3) 工場にて取付済み
 - * 4) 防水のためテープで処理すること
 - * 5) メニュー切替
 - * 6) 方位出力が停止したとき、接点回路がオープンになる。
 - * 7) ケーブルクランプで接地する

- NOTE
- *1. SHIPYARD SUPPLY
 - *2. OPTION
 - *3. FITTED AT FACTORY.
 - *4. TAPE FOR WATERPROOFING
 - *5. CHANGE WITH MENU
 - *6. IF THE HEADING OUTPUT STOPS, THE CONTACT CIRCUIT OPENS.
 - *7. GROUND THROUGH CABLE CLAMP

演算部 PROCESSOR UNIT SC-501

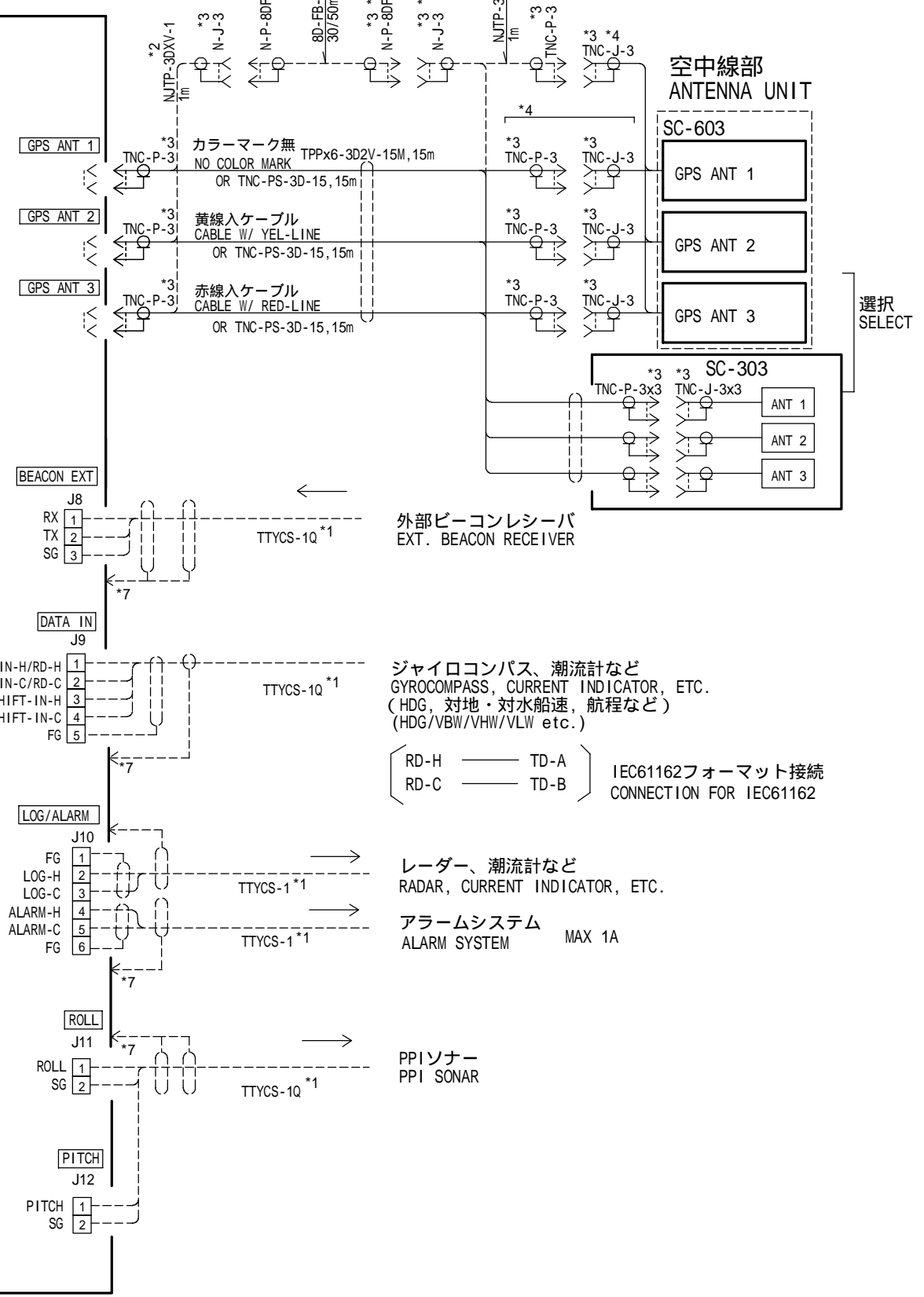

DRAWN Oct. 12, '05	E. MIYOSHI	TITLE	SC-50
CHECKED	TAKAHASHI.T	名称	サテライトコンパス
APPROVED	Y. Hatai		相互結線図
SCALE	MASS	NAME	SATELLITE COMPASS
DWG No.	C7251-C01 - E		INTERCONNECTION DIAGRAM

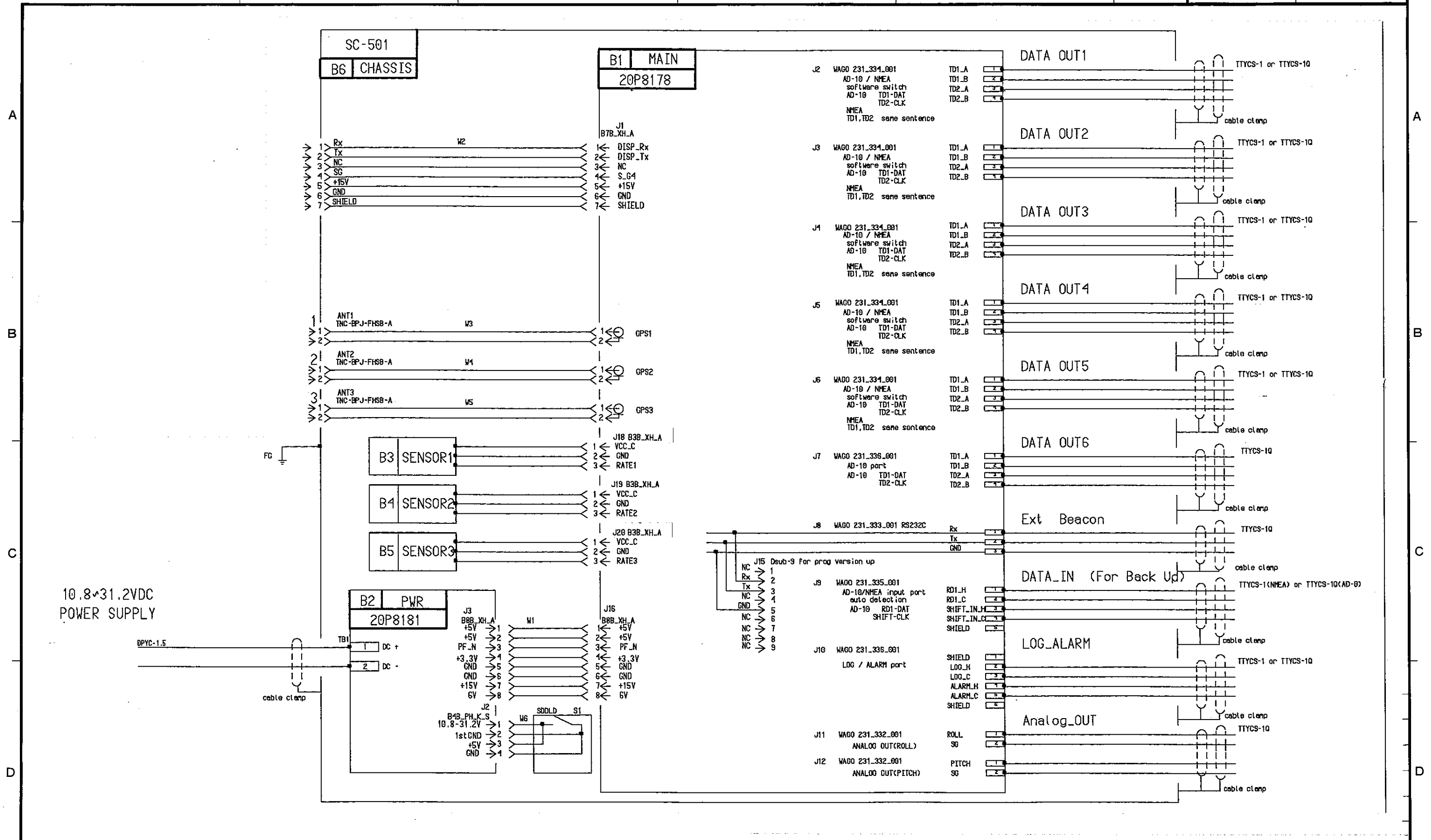

DRAWN 04/09/21 T. YAMASAKI	TYPE SC-510
CHECKED 04/09/21 K. Okamoto	名称 演算部
APPROVED Sep 24/04 H. Iiyama	回路図
SCALE MASS	MODEL BLOCK No.
Dwg No. C7251-K01- A	NAME PROCESSOR UNIT
	SCHEMATIC DIAGRAM

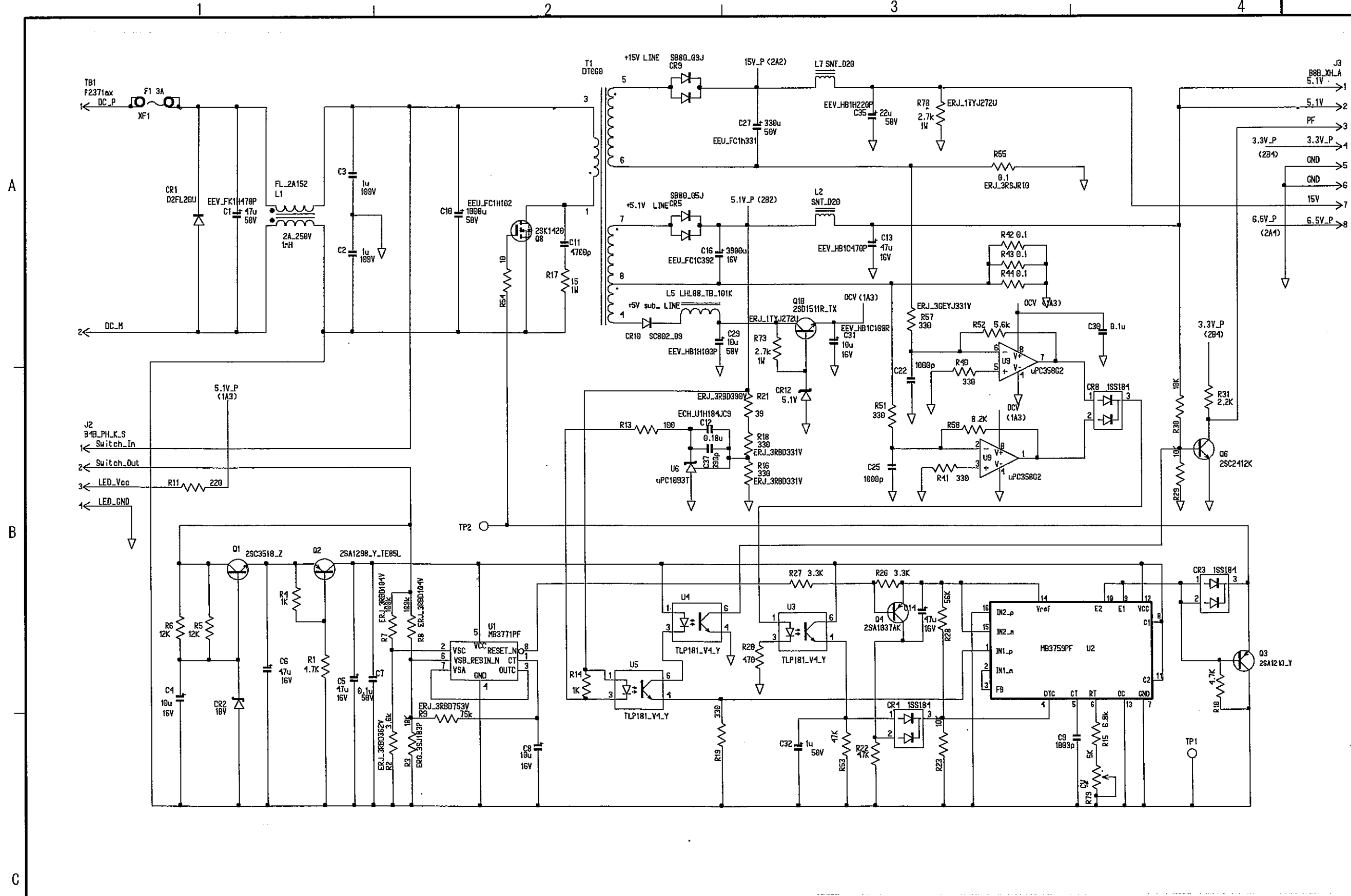

DRAWN 04/09/21 T. YAMASAKI	TYPE 20P8181 (1/2)
CHECKED 04/09/21 K. Okamoto	名称 電源基板
APPROVED Sep. 24 '04 H. Nagashima	回路図
SCALE MASS	NAME PWR PCB
Dwg No. G7251-K02- A	SC-510 1 B2 MODEL BLOCK No. 20-024-5101-1
SCHEMATIC DIAGRAM	

4

3

2

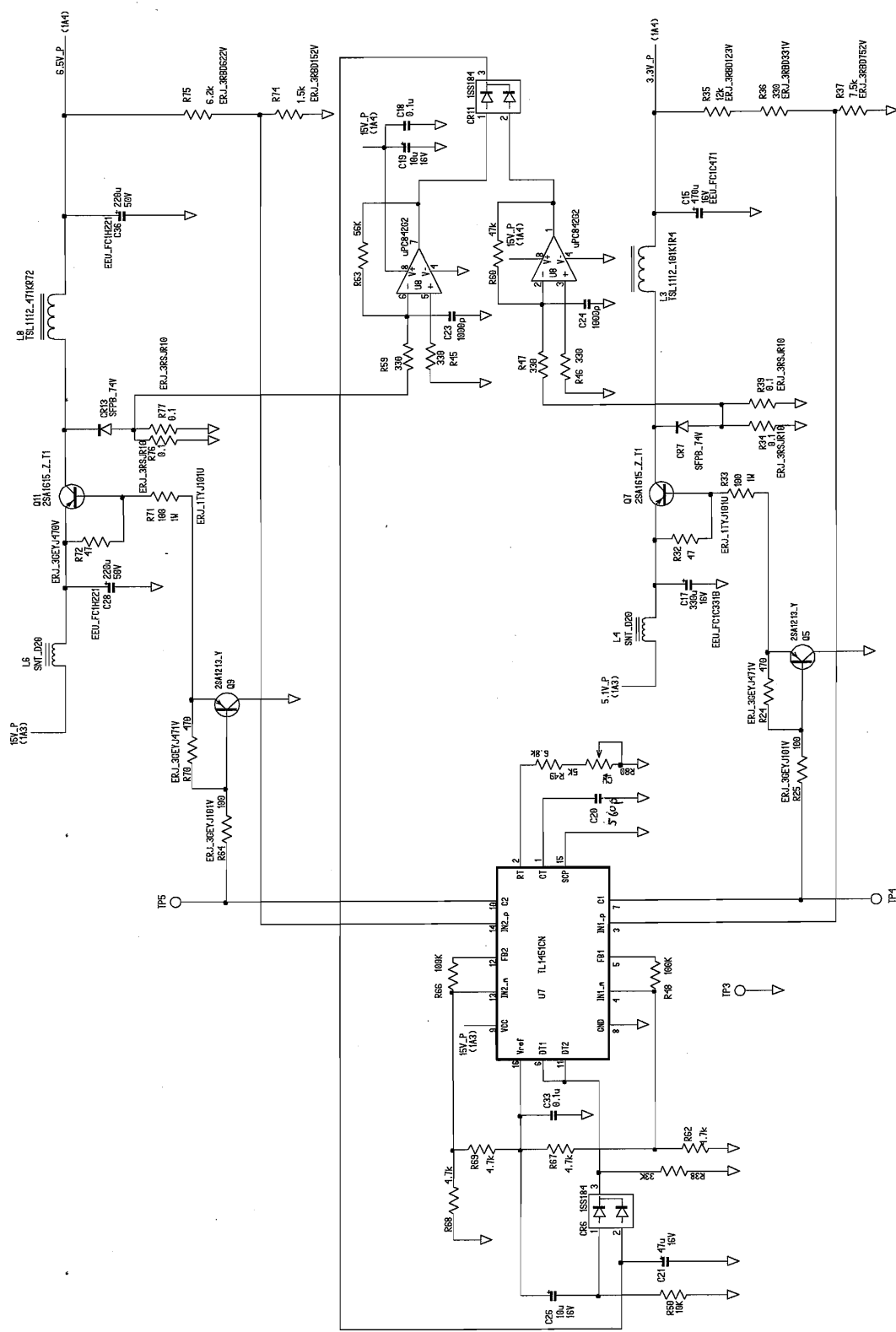

A

B

C

DRAWN	04/09/21	T. YAMASAKI	TYPE	20P8181 (2/2)
CHECKED			名称	電源基板
APPROVED		<i>K. Okamoto</i>	回路図	
SCALE	1 B2	SC-510	MODEL	
SCALE	1 B2	SC-510	BLOCK No.	
SCALE	1 B2	SC-510	NAME	PWR POB
SCALE	1 B2	SC-510	SCHEMATIC DIAGRAM	
Dwg No.	C7251-K03-A	20-024-5102-1		